

## PIT - MONOPOINT SUSPENSION

### D141180-

base number      Finish Options      -      Finish Options

- To build a product code in our configurator select the specify button on the base model # product page
- To build a manual product code on this datasheet choose from the options listed below in blue font and add the suffix to the base model #

#### GENERAL

Series: Pit  
 Subseries: Pit - Monopoint  
 Brand: Cangini & Tucci  
 Division: Design  
 Mounting Type: Suspension  
 Mounting Location: Ceiling  
 Subcategory: Pendant

#### PHYSICAL

Shape: Sphere  
 Diameter (mm): 220  
 Diameter (in): 8 <sup>11</sup>/<sub>16</sub>  
 Height (mm): 220  
 Height (in): 8 <sup>11</sup>/<sub>16</sub>  
 Max. Overall Height (mm): 2220  
 Max. Overall Height (in): 87 <sup>3</sup>/<sub>8</sub>  
 Light Distribution: Omnidirectional  
 Weight (kg): 0.750  
 Weight (lbs): 1.65  
 Fixture Finish: [AMB / GRN / PNK / RUB / SKB / SMK / TOB / TRA](#)  
 Holder Finish: CHR / WHI / BLK / BCR  
 Fixture Material: Glass / Metal  
 Cable Details: 2000mm / 78 3/4" - Transparent Cable  
 Upon Request: On Demand Holder Finishes - Satin Gold, Satin Bronze or Satin Black Nickel

#### ELECTRICAL

Lamp Type: LED  
 Input Wattage (W): 7.8  
 Total Output Wattage (W): 6  
 Dimming: Non-Dimmable  
 Driver Included: Yes  
 Driver Location: Integrated  
 Input Voltage (V): 120  
 Constant Current (MA): 500mA  
 Upon Request: Phase Dimming (120Vac only) / 0-10V Dimming

#### LED

Color Temperature (°K): 3000  
 Max. Delivered Lumen (lm): 864  
 Nominal Lumen (lm): 886  
 CRI: >90 CRI

#### OPTICAL

#### RATINGS AND CERTIFICATIONS

Certified By: Certified for North American Standards  
 IP rating: IP20

PROJECT
TYPE
SPECIFIER
QUANTITY
DATE

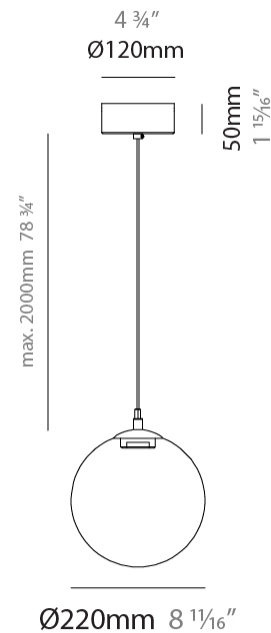

## PIT - MONOPOINT SUSPENSION

D141180-

PROJECT	_____
TYPE	_____
SPECIFIER	_____
QUANTITY	_____
DATE	_____

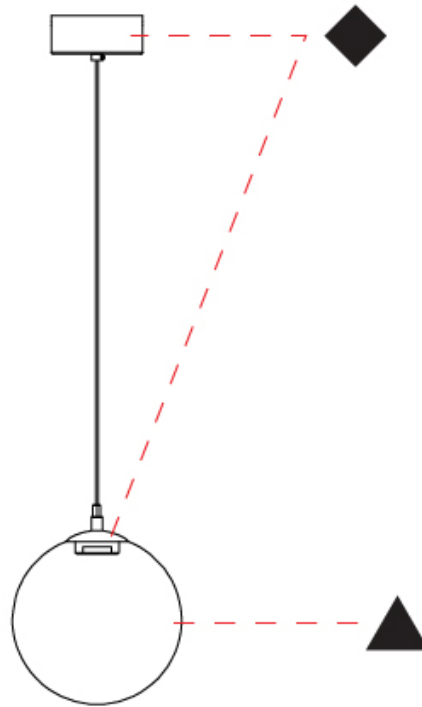

D

## PIT - MONOPOINT SUSPENSION

### D141181-

base number      Finish      Finish  
Options            Options

- To build a product code in our configurator select the specify button on the base model # product page
- To build a manual product code on this datasheet choose from the options listed below in blue font and add the suffix to the base model #

#### GENERAL

Series: Pit  
Subseries: Pit - Monopoint  
Brand: Cangini & Tucci  
Division: Design  
Mounting Type: Suspension  
Mounting Location: Ceiling  
Subcategory: Pendant

#### PHYSICAL

Shape: Sphere  
Diameter (mm): 260  
Diameter (in): 10 ¼  
Height (mm): 260  
Height (in): 10 ¼  
Max. Overall Height (mm): 2260  
Max. Overall Height (in): 89  
Light Distribution: Omnidirectional  
Weight (kg): 0.900  
Weight (lbs): 1.98  
Fixture Finish: [AMB / GRN / PNK / RUB / SKB / SMK / TOB / TRA](#)  
Holder Finish: CHR / WHI / BLK / BCR  
Fixture Material: Glass / Metal  
Cable Details: 2000mm / 78 ¾" - Transparent Cable  
Upon Request: On Demand Holder Finishes - Satin Gold, Satin Bronze or Satin Black Nickel

#### ELECTRICAL

Lamp Type: LED  
Input Wattage (W): 7.8  
Total Output Wattage (W): 6  
Dimming: Non-Dimmable  
Driver Included: Yes  
Driver Location: Integrated  
Input Voltage (V): 120  
Constant Current (MA): 500mA  
Upon Request: Phase Dimming (120Vac only) / 0-10V Dimming

#### LED

Color Temperature (°K): 3000  
Max. Delivered Lumen (lm): 866  
Nominal Lumen (lm): 886  
CRI: >90 CRI

#### OPTICAL

#### RATINGS AND CERTIFICATIONS

Certified By: Certified for North American Standards  
IP rating: IP20

PROJECT
TYPE
SPECIFIER
QUANTITY
DATE

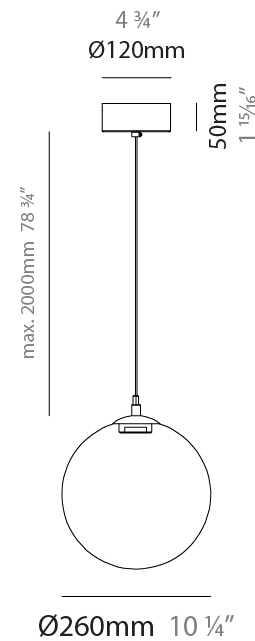

## PIT - MONOPOINT SUSPENSION

D141181-

PROJECT

TYPE

SPECIFIER

QUANTITY

DATE

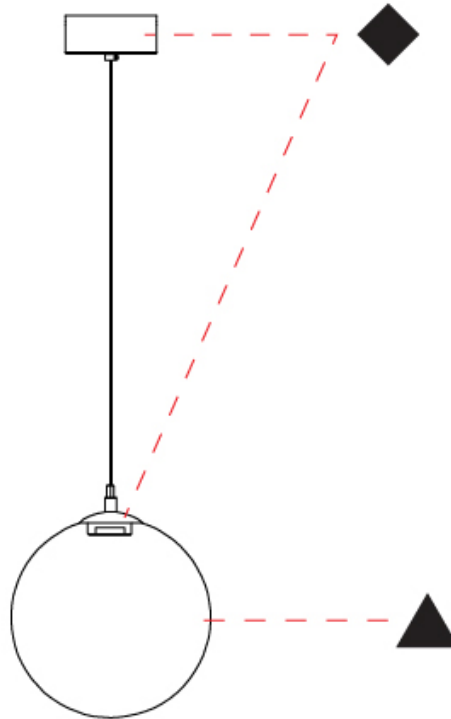

D

PROJECT	
TYPE	
SPECIFIER	
QUANTITY	
DATE	

## PIT - MONOPOINT SUSPENSION

### D141182-

base number      Finish      Finish  
Options            Options

- To build a product code in our configurator select the specify button on the base model # product page
- To build a manual product code on this datasheet choose from the options listed below in blue font and add the suffix to the base model #

#### GENERAL

Series: Pit  
Subseries: Pit - Monopoint  
Brand: Cangini & Tucci  
Division: Design  
Mounting Type: Suspension  
Mounting Location: Ceiling  
Subcategory: Pendant

#### PHYSICAL

Shape: Sphere  
Diameter (mm): 300  
Diameter (in): 11 <sup>13</sup>/<sub>16</sub>  
Height (mm): 300  
Height (in): 11 <sup>13</sup>/<sub>16</sub>  
Max. Overall Height (mm): 2300  
Max. Overall Height (in): 90 <sup>9</sup>/<sub>16</sub>  
Light Distribution: Omnidirectional  
Weight (kg): 1.100  
Weight (lbs): 2.43  
Fixture Finish: [AMB / GRN / PNK / RUB / SKB / SMK / TOB / TRA](#)  
Holder Finish: CHR / WHI / BLK / BCR  
Fixture Material: Glass / Metal  
Cable Details: 2000mm / 78 3/4" - Transparent Cable  
Upon Request: On Demand Holder Finishes - Satin Gold, Satin Bronze or Satin Black Nickel

#### ELECTRICAL

Lamp Type: LED  
Input Wattage (W): 7.8  
Total Output Wattage (W): 6  
Dimming: Non-Dimmable  
Driver Included: Yes  
Driver Location: Integrated  
Input Voltage (V): 120  
Constant Current (MA): 500mA  
Upon Request: Phase Dimming (120Vac only) / 0-10V Dimming

#### LED

Color Temperature (°K): 3000  
Max. Delivered Lumen (lm): 866  
Nominal Lumen (lm): 886  
CRI: >90 CRI

#### OPTICAL

#### RATINGS AND CERTIFICATIONS

Certified By: Certified for North American Standards  
IP rating: IP20

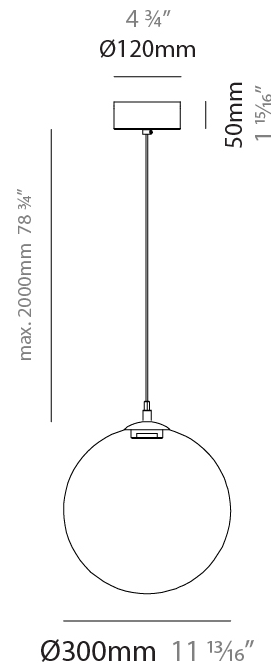

## PIT - MONOPOINT SUSPENSION

D141182-

PROJECT	_____
TYPE	_____
SPECIFIER	_____
QUANTITY	_____
DATE	_____

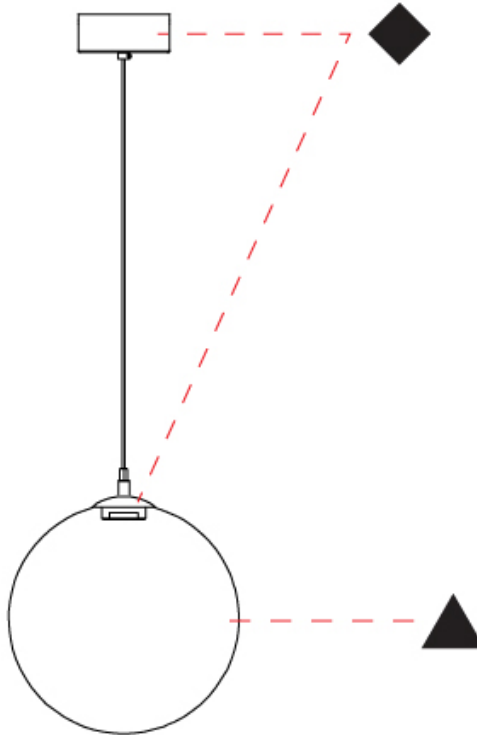

D

PROJECT
TYPE
SPECIFIER
QUANTITY
DATE

## PIT PORTABLE

### D144036-

base number      Color      Finish      Finish  
 Temperature      Options      Options

- To build a product code in our configurator select the specify button on the base model # product page
- To build a manual product code on this datasheet choose from the options listed below in blue font and add the suffix to the base model #

#### GENERAL

Series: Pit  
 Brand: Cangini & Tucci  
 Division: Design  
 Mounting Type: Portable  
 Mounting Location: Table  
 Subcategory: Table

#### PHYSICAL

Shape: Sphere  
 Diameter (mm): 220  
 Diameter (in): 8 11/16  
 Height (mm): 500  
 Height (in): 19 11/16  
 Light Distribution: Omnidirectional  
 Weight (kg): 1.8  
 Fixture Finish: [AMB](#) / [GRN](#) / [PNK](#) / [RUB](#) / [SKB](#) / [SMK](#) / [TOB](#) / [TRA](#)  
 Holder Finish: [SGD](#) / [SRG](#) / [SBN](#)  
 Fixture Material: Glass / Metal  
 Cable Details: 2000mm / 78 3/4" - Transparent Cable

#### ELECTRICAL

Lamp Type: LED  
 Input Wattage (W): 6  
 Dimming: Non-Dimmable  
 Driver Included: Yes  
 Driver Location: Integrated  
 Driver Type: Constant Current - Universal  
 Driver Class: Class 2  
 Input Voltage (V): 120 - 277  
 Constant Current (MA): 500

#### LED

Color Temperature (°K): [2700](#) / [3000](#)  
 Max. Delivered Lumen (lm): 144  
 Nominal Lumen (lm): 866  
 CRI: >90 CRI  
 Lamp Life (hrs): 50000

#### OPTICAL

#### RATINGS AND CERTIFICATIONS

Certified By: Certified for North American Standards  
 IP rating: IP20

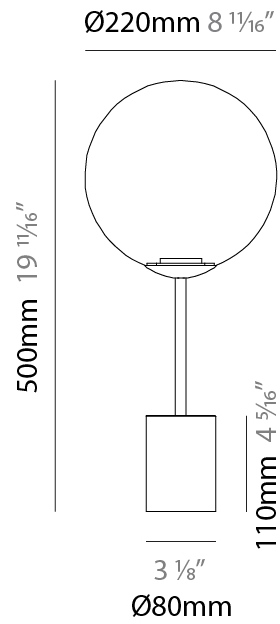

## PIT PORTABLE

D144036-

PROJECT
TYPE
SPECIFIER
QUANTITY
DATE

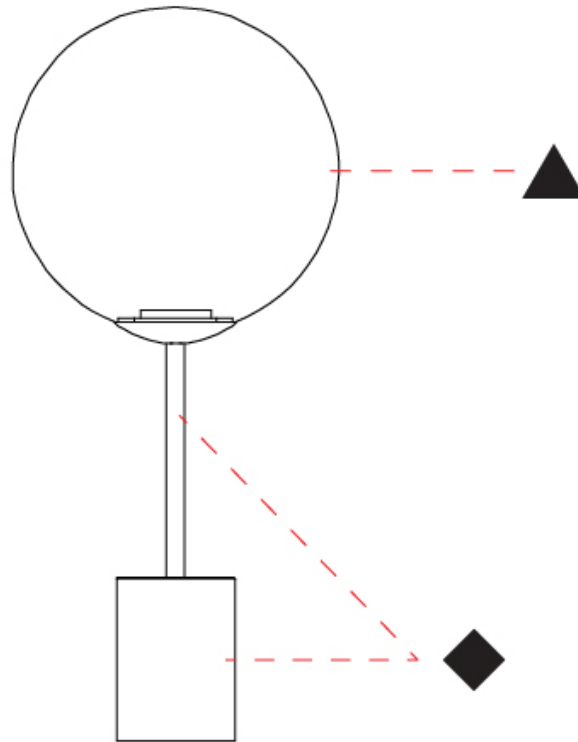

D



PROJECT	_____
TYPE	_____
SPECIFIER	_____
QUANTITY	_____
DATE	_____

## PIT PORTABLE

### D144037-

base number	Color	Finish	Finish
	Temperature	Options	Options

- To build a product code in our configurator select the specify button on the base model # product page
- To build a manual product code on this datasheet choose from the options listed below in blue font and add the suffix to the base model #

#### GENERAL

Series: Pit
Brand: Cangini & Tucci
Division: Design
Mounting Type: Portable
Mounting Location: Floor
Subcategory: Table

#### PHYSICAL

Shape: Sphere
Diameter (mm): 300
Diameter (in): 11 <sup>13</sup> / <sub>16</sub>
Height (mm): 1750
Height (in): 68 <sup>7</sup> / <sub>8</sub>
Light Distribution: Omnidirectional
Weight (kg): 5.3
Fixture Finish: <a href="#">AMB</a> / <a href="#">GRN</a> / <a href="#">PNK</a> / <a href="#">RUB</a> / <a href="#">SKB</a> / <a href="#">SMK</a> / <a href="#">TOB</a> / <a href="#">TRA</a>
Holder Finish: <a href="#">SGD</a> / <a href="#">SRG</a> / <a href="#">SBN</a>
Fixture Material: Glass / Metal
Cable Details: 2000mm / 78 3/4" - Transparent Cable

#### ELECTRICAL

Lamp Type: LED
Input Wattage (W): 8.4
Dimming: Non-Dimmable
Driver Included: Yes
Driver Location: Integrated
Driver Type: Constant Current - Universal
Driver Class: Class 2
Input Voltage (V): 120
Constant Current (MA): 700
Upon Request: Phase Dimming

#### LED

Color Temperature (°K): <a href="#">2700</a> / <a href="#">3000</a>
Max. Delivered Lumen (lm): 144
Nominal Lumen (lm): 1200
CRI: >90 CRI
Lamp Life (hrs): 50000

#### OPTICAL

#### RATINGS AND CERTIFICATIONS

Certified By: Certified for North American Standards
IP rating: IP20



Ø300mm 11 <sup>13</sup>/<sub>16</sub>"

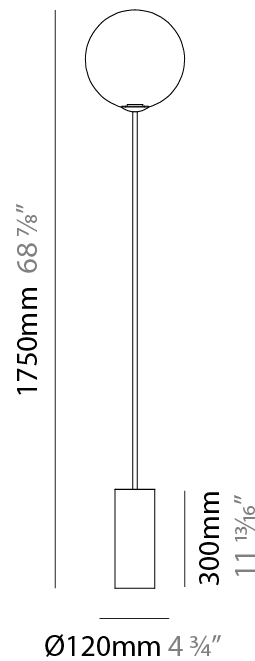

PROJECT
TYPE
SPECIFIER
QUANTITY
DATE

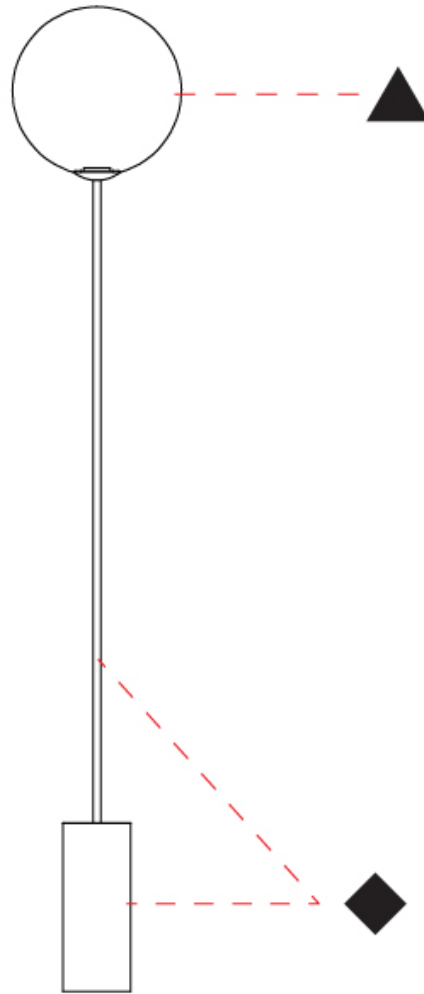

## PIT

### COLOR FINISH CHART

#### Fixture Finish

Amber - AMB



Green - GRN



Pink - PNK



Ruby - RUB



Sky Blue - SKB



Smoke - SMK



Tobacco - TOB



Transparent - TRA



#### Holder Finish

Chrome - CHR



White - WHI

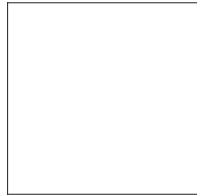

Black - BLK



Brushed Chrome - BCR

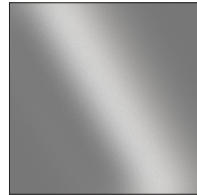

Satin Gold - SGD



Satin Rose Gold - SRG

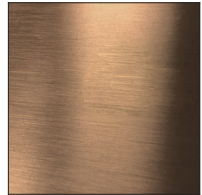

Satin Black Nickel - SBN

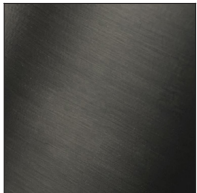

**Digital:** Not all screens are calibrated the same, and therefore, colors will appear differently between screens.

**Physical:** When texture is involved, there will be variations in color, character and tone within a product series and between product families.



### LEGEND

	floor-mounted		pivotal		special LED (upon request) RGB, RGBW, tunable, gold+, meat+, art+, fashion+
	wall and ceiling: recessed and surface mounted		rotating		warm dim / natural dimming LED
	ceiling-mounted and wall-mounted		illuminate tilted		rechargeable battery powered
	wall-mounted		color of suspension cable		fixture with natural vivid LED (upon request)
	omni-directional light distribution		length of suspension cable		color rendering index
	direct light distribution		reflector degree selection		color temperature
	direct/indirect light distribution		super spot		lumen (luminous flux)
	indirect light distribution		lens		efficacy (lumens per watt)
	asymmetric light distribution		lens pack		Unified Glare Rating (UGR) range from 5-40
	aura light distribution		shine ring		marine grade (AISI 316 stainless steel)
	round wall or ceiling cut-out		integrated shine ring with diffuser		walk on
	square wall or ceiling cut-out		free individual colors 01-29		drive on
	the supplied jig specifies the cutout dimensions		individual colors: 00 (free of charge), 01-25 (extra charge)		Dark Sky Compliance
	minimum distance (meters) lamp - object		luminaire part to be colored (F1)		Americans with Disabilities Act (less than 4" off the wall located between 27"-84" from floor)
	recessed depth		luminaire part to be colored (F2)		lamp protected against explosion
	ceiling thickness in mm		luminaire part to be colored (F3)		blown glass using traditional methods by master glass blower
	ceiling thickness selection		luminaire part to be colored (F4)		acoustic material
	dimnable DP (phase), DV (0-10V), DD (dali), DS (step-dim)		luminaire part to be colored (F5)		protection class I, protection insulation
	included or excluded LED driver/transformer/control gear		color of 3-circuit adaptor		protection class II, protection insulation
	separately switchable		indirect diffuser		ETL Certified to UL and CSA Standards
	sensor		direct diffuser		UL Certified to UL and CSA Standards
	remote control		ball-proof (upon request)		CSA Certified to UL and CSA Standards
	available upon request		accessory		Certified for North American Standards

### IP RATING

	protected against ingress of solid bodies greater than 12.5mm (finger)
	protected against ingress of solid bodies greater than 2.5mm protected against sprays of water up to 60 degrees from the vertical (rain)
	protected against ingress of solid bodies greater than 1mm (wire) no protection against the ingress of moisture
	protected against ingress of solid bodies greater than 1mm (wire) protected against sprays of water up to 60 degrees from the vertical (rain)
	protected against ingress of solid bodies greater than 1mm (wire) protected against water splashed from all directions
	protected against limited ingress of dust (wet rooms/covered outdoor areas) protected against water splashed from all directions
	protected against ingress of dust protected against jets of water
	protected against ingress of dust protected against powerful jets of water or heavy seas
	protected against ingress of dust protected against immersion of water between 15cm - 1m for 30 minutes
	protected against ingress of dust protected against immersion of water under pressure for long periods

### IK RATING

	protected against 0.14 joules impact (equivalent to 0.25kg mass dropped from 56mm above the surface)
	protected against 0.2 joules impact (equivalent to 0.25kg mass dropped from 80mm above the surface)
	protected against 0.35 joules impact (equivalent to 0.25kg mass dropped from 140mm above the surface)
	protected against 0.5 joules impact (equivalent to 0.25kg mass dropped from 200mm above the surface)
	protected against 0.7 joules impact (equivalent to 0.25kg mass dropped from 280mm above the surface)
	protected against 1 joules impact (equivalent to 0.25kg mass dropped from 400mm above the surface)
	protected against 2 joules impact (equivalent to 0.5kg mass dropped from 400mm above the surface)
	protected against 5 joules impact (equivalent to 1.7kg mass dropped from 300mm above the surface)
	protected against 10 joules impact (equivalent to 5.0kg mass dropped from 200mm above the surface)
	protected against 20 joules impact (equivalent to 5.0kg mass dropped from 400mm above the surface)